



Instituto Tecnológico de Aeronáutica
Divisão de Engenharia Aeronáutica e Aeroespacial

AB-271 - Abordagem porta-Hamiltoniana para modelagem, simulação e controle

Professor:

Flávio Ribeiro (flaviocr@ita.br)

Sala: 2411

Site: <http://flavioluiz.github.io>

- 1 A very short introduction to port-Hamiltonian systems
- 2 A few nice applications...
- 3 Why PHS?

Overview

- 1 A very short introduction to port-Hamiltonian systems
- 2 A few nice applications...
- 3 Why PHS?

Introduction to port-Hamiltonian systems (modeling by interconnection)

The port-Hamiltonian formalism (Maschke, van der Schaft, 1992) brings together:

Introduction to port-Hamiltonian systems (modeling by interconnection)

The port-Hamiltonian formalism (Maschke, van der Schaft, 1992) brings together:

- Hamiltonian mechanics;

Introduction to port-Hamiltonian systems (modeling by interconnection)

The port-Hamiltonian formalism (Maschke, van der Schaft, 1992) brings together:

- Hamiltonian mechanics;
- Port-based modeling approach (bond-graph);
 - ▶ Different domains (mechanical, electrical, hydraulic, thermal)
 - ▶ Energy is the *lingua franca*;
 - ▶ Complex systems are written as a composition of ideal components: energy-storage, energy-dissipation, energy-routing, etc.

Introduction to port-Hamiltonian systems (modeling by interconnection)

The port-Hamiltonian formalism (Maschke, van der Schaft, 1992) brings together:

- Hamiltonian mechanics;
- Port-based modeling approach (bond-graph);
 - ▶ Different domains (mechanical, electrical, hydraulic, thermal)
 - ▶ Energy is the *lingua franca*;
 - ▶ Complex systems are written as a composition of ideal components: energy-storage, energy-dissipation, energy-routing, etc.
- Passive systems and control theory.

Simple example of port-Hamiltonian system

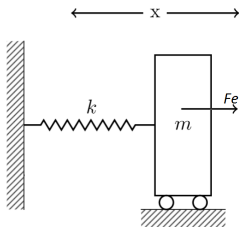

From Newton 2nd Law:

$$m\ddot{x} + kx = F_{ext},$$

System energy:

$$E = \frac{m\dot{x}^2}{2} + \frac{kx^2}{2}$$

Simple example of port-Hamiltonian system

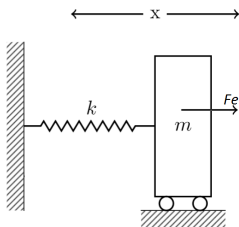

From Newton 2nd Law:

$$m\ddot{x} + kx = F_{\text{ext}},$$

System energy:

$$E = \frac{m\dot{x}^2}{2} + \frac{kx^2}{2}$$

By choosing $p = m\dot{x}$ then $H(p, x) = \frac{p^2}{2m} + \frac{kx^2}{2}$

$$\begin{bmatrix} \dot{p} \\ \dot{x} \end{bmatrix} = \begin{bmatrix} 0 & -1 \\ 1 & 0 \end{bmatrix} \begin{bmatrix} \frac{p}{m} \\ kx \end{bmatrix} + \begin{bmatrix} 1 \\ 0 \end{bmatrix} F_{\text{ext}},$$

$$\dot{x} = \begin{bmatrix} 1 & 0 \\ 0 & 1 \end{bmatrix} \begin{bmatrix} \frac{p}{m} \\ kx \end{bmatrix}$$

Simple example of port-Hamiltonian system

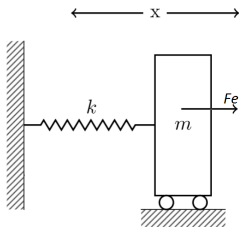

From Newton 2nd Law:

$$m\ddot{x} + kx = F_{ext},$$

System energy:

$$E = \frac{m\dot{x}^2}{2} + \frac{kx^2}{2}$$

By choosing $p = m\dot{x}$ then $H(p, x) = \frac{p^2}{2m} + \frac{kx^2}{2}$

$$\begin{bmatrix} \dot{p} \\ \dot{x} \end{bmatrix} = \underbrace{\begin{bmatrix} 0 & -1 \\ 1 & 0 \end{bmatrix}}_J \begin{bmatrix} \partial_p H \\ \partial_x H \end{bmatrix} + \begin{bmatrix} 1 \\ 0 \end{bmatrix} F_{ext},$$

$$\dot{x} = \begin{bmatrix} 1 & 0 \end{bmatrix} \begin{bmatrix} \partial_p H \\ \partial_x H \end{bmatrix}$$

$$\implies \dot{H} = F_{ext}\dot{x}$$

F_{ext} and \dot{x} are the interconnection ports.

Typical mathematical representation of finite-dimensional port-Hamiltonian systems

$$\begin{aligned}\dot{x} &= J \frac{\partial H}{\partial x} + B u, \\ y &= B^T \frac{\partial H}{\partial x}.\end{aligned}$$

where:

$H(x)$: system Hamiltonian;

$x \in R^n$: energy variables;

$u \in R^m$: inputs;

$y \in R^m$: outputs;

J : interconnection matrix (skew-symmetric);

$$\implies \dot{H} = y^T u$$

u and y are said to be (power-)conjugated.

The interconnection of two (N) PHS is still a PHS

Individual systems

$$\dot{x}_1 = J_1 \frac{\partial H_1}{\partial x_1} + B_1 u_1,$$

$$y_1 = B_1^T \frac{\partial H_1}{\partial x_1},$$

$$\dot{x}_2 = J_2 \frac{\partial H_2}{\partial x_2} + B_2 u_2,$$

$$y_2 = B_2^T \frac{\partial H_2}{\partial x_2},$$

Interconnection

$$u_1 = y_2 + u_e,$$

$$u_2 = -y_1$$

\implies

Coupled system

$$H(x_1, x_2) = H_1(x_1) + H_2(x_2)$$

$$\begin{bmatrix} \dot{x}_1 \\ \dot{x}_2 \end{bmatrix} = \begin{bmatrix} J_1 & B_1 B_2^T \\ -B_2 B_1^T & J_2 \end{bmatrix} \begin{bmatrix} \frac{\partial H}{\partial x_1} \\ \frac{\partial H}{\partial x_2} \end{bmatrix} + \begin{bmatrix} B_1 \\ 0 \end{bmatrix} u_e,$$

$$y_e = \begin{bmatrix} B_1 & 0 \end{bmatrix} \begin{bmatrix} \frac{\partial H}{\partial x_1} \\ \frac{\partial H}{\partial x_2} \end{bmatrix}$$

$$\frac{dH}{dt} = y_e^T u_e$$

PHSs are convenient for (non-linear) control design

Typical port-Hamiltonian representation:

$$\begin{aligned}\dot{x} &= J \frac{\partial H}{\partial x}(x) + Bu, \\ y &= B^T \frac{\partial H}{\partial x}(x).\end{aligned}$$

We've seen that: $\dot{H} = y^T u$

What happens if $u = -K(x)y$, with $K(x) > 0$?

$$\dot{H} = -y^T K(x)y \leq 0,$$

If $H(x)$ is lower bounded, the controlled system is stable!

Overview

- 1 A very short introduction to port-Hamiltonian systems
- 2 A few nice applications...
- 3 Why PHS?

Inverted pendulum

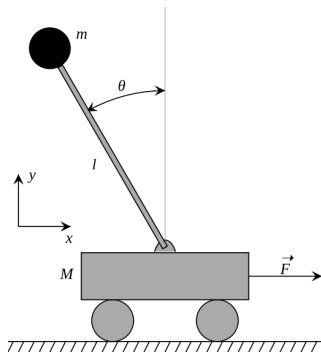

Inverted pendulum

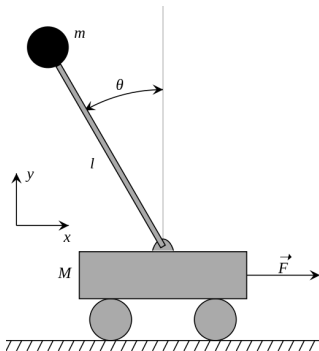

Delgado, S., and P. Kotyczka. "Passivitätsbasierte Positions- und Geschwindigkeitsregelung eines Segway-Systems." Vortrag bei der Sitzung des GMA-Fachausschusses 1.40" Theoretische Verfahren der Regelungstechnik". 2014.



Walking robot



Duindam, V. (2006). "Port-Based Modeling and Control for Efficient Bipedal Walking Robots." PhD thesis. Universiteit Twente.

Modeling and control of irrigation water channels



Hamroun, B., Dimofte, A., Lefèvre, L., Mendes, E. (2010). Control by Interconnection and Energy-Shaping Methods of Port Hamiltonian Models. Application to the Shallow Water Equations. *European Journal of Control*, 16(5), 545–563.

Robotized brass instruments

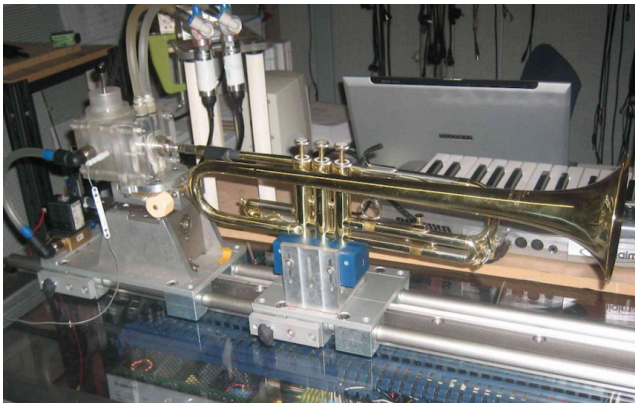

Lopes, N. (2016). "Approche passive pour la modélisation, la simulation et l'étude d'un banc de test robotisé pour les instruments de type cuivre." PhD. Université Pierre et Marie Curie - Paris VI.

Tokamak nuclear reactor

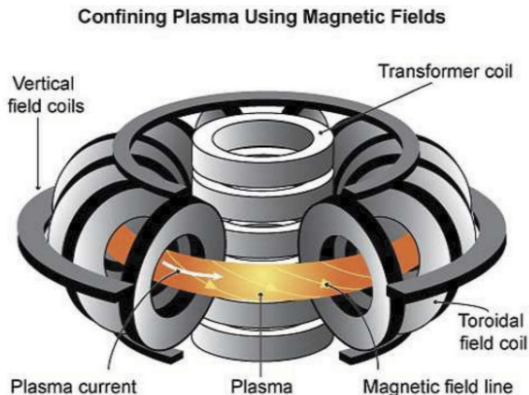

Vu, N. M. T., Lefèvre, L., Maschke, B. (2016). A structured control model for the thermo-magneto-hydrodynamics of plasmas in tokamaks. *Mathematical and Computer Modelling of Dynamical Systems*, 3954(March), 1–26.

Nanotweezer for DNA manipulation

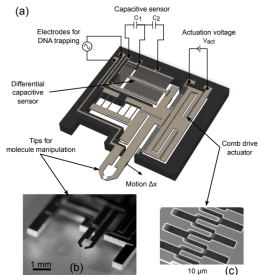

H. Ramirez, Y. Le Gorrec, A. Macchelli, and H. Zwart, "Exponential stabilization of boundary controlled port-Hamiltonian systems with dynamic feedback," *Automatic Control, IEEE Transactions on*, vol. 59, no. 10, pp. 2849–2855, Oct 2014.

Smart grid stability analysis

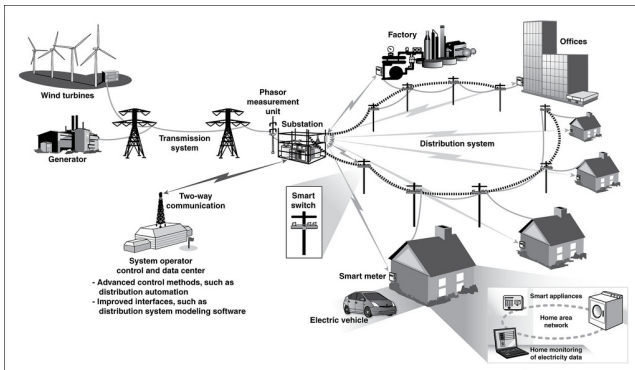

Source: GAO analysis.



Shaik, Fiaz, et al. "Port Hamiltonian modeling of power networks." 20th International Symposium on Mathematical Theory of Networks and Systems. 2012.



Stegink, T. W., C. De Persis, and A. J. van der Schaft. "Port-Hamiltonian formulation of the gradient method applied to smart grids." IFAC-PapersOnLine 48.13 (2015): 13-18.

Fluid-structure system excited by piezoelectric actuators

- Very flexible plate

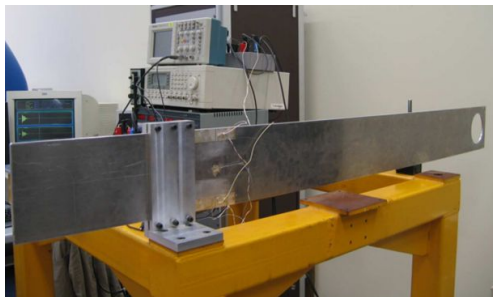

Fluid-structure system excited by piezoelectric actuators

- Very flexible plate

+

- Partially filled tank

= fluid/structure
interactions

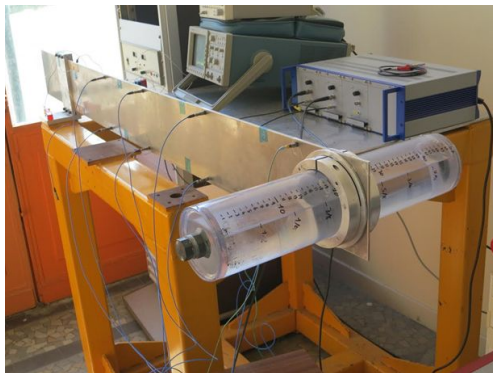

Fluid-structure system excited by piezoelectric actuators

- Very flexible plate

+

- Partially filled tank

= fluid/structure interactions

- Piezoelectric patches as actuators
- Accelerometers as sensors

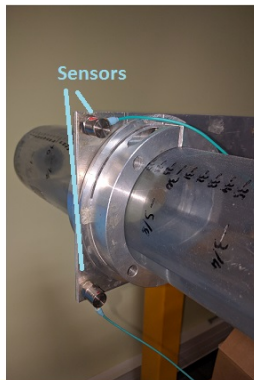

Cardoso-Ribeiro, F. L., Matignon, D., Pommier-Budinger, V. (2017). A port-Hamiltonian model of liquid sloshing in moving containers and application to a fluid-structure system. *J. of Fluids and Structures*, 69(December 2016), 402–427.



Cardoso-Ribeiro, F. L. (2016). Port-Hamiltonian modeling and control of a fluid-structure system - Application to sloshing phenomena in a moving container coupled to a flexible structure. University of Toulouse.

Control of a rotating flexible satellite

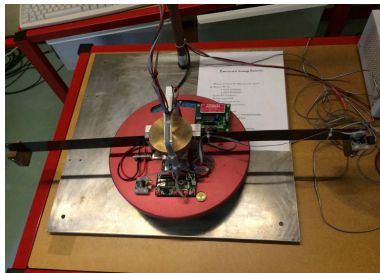
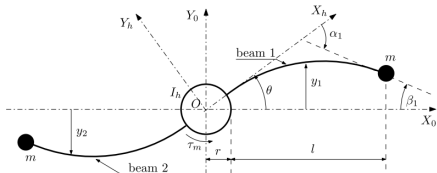

Aloues, S., Cardoso-Ribeiro, F. L., Matignon, D., Alazard, D. (2017). Modeling and Control of a Rotating Flexible Spacecraft: A Port-Hamiltonian Approach. IEEE Transactions on Control Systems Technology, 1–8.

Overview

- 1 A very short introduction to port-Hamiltonian systems
- 2 A few nice applications...
- 3 Why PHS?**

PHS is a "hot topic" for different communities

Mathematics and PDEs:

Analysis results for infinite-dimensional systems



Jacob, Birgit, and Hans J. Zwart. Linear port-Hamiltonian systems on infinite-dimensional spaces. Vol. 223. Springer Science Business Media, 2012.

Modeling and control:

- Modeling is physically motivated;
- Physical properties can be used for a more "natural" control;
- (Power-preserving) interconnection can be used for coupling complex, multi-physical systems;

Simulation:

- Time and space discretization can preserve physical properties;
- More efficient simulation schemes.